

# LEDEEN Actuator and Control Solutions

Innovative solutions for pneumatic, hydraulic, gas-over-oil, direct gas, and subsea applications.

TECHNOLOGY

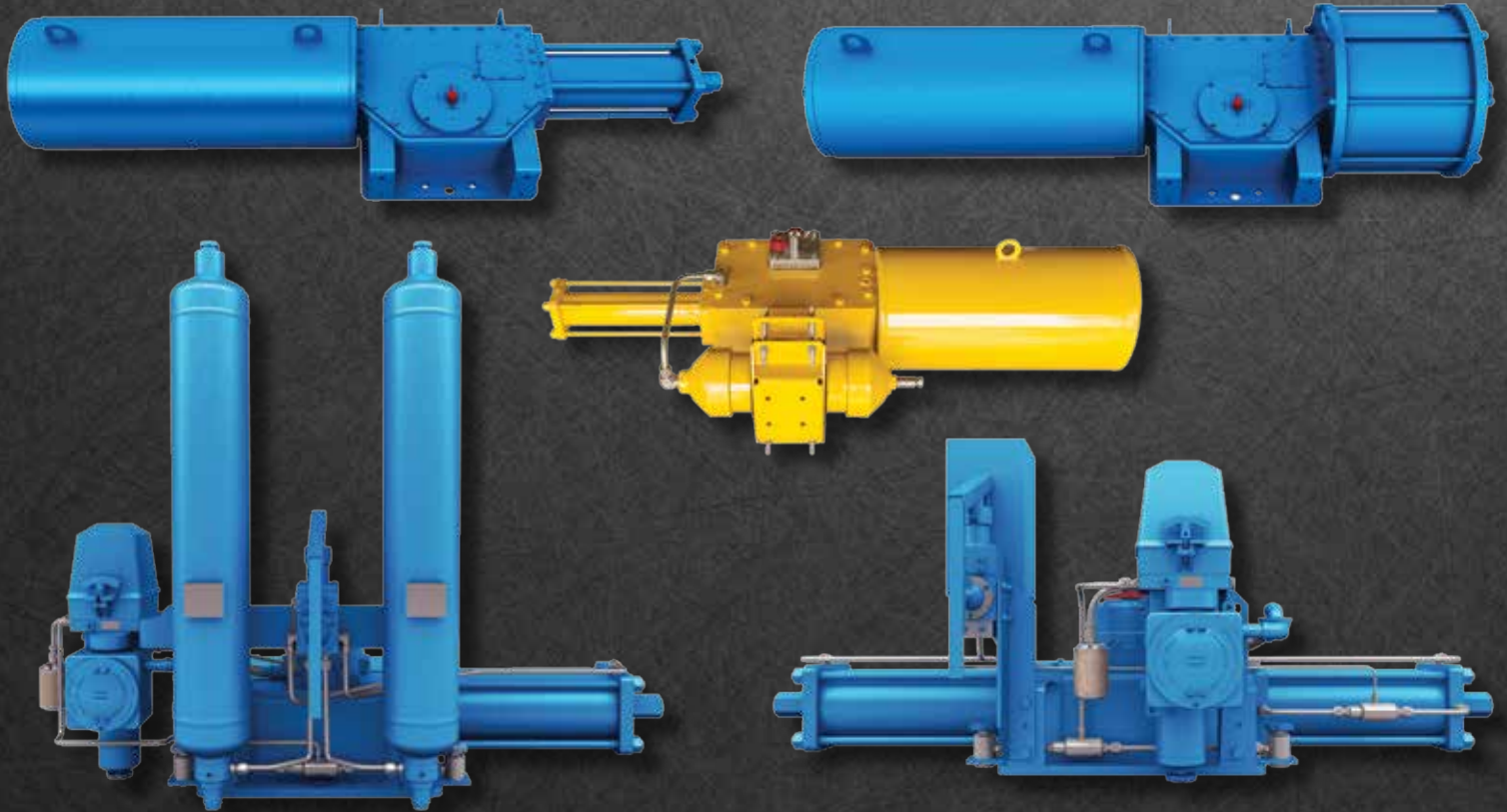

## Table of Contents

### LEDEEN ACTUATOR AND CONTROL SOLUTIONS

Introduction.....	2
<b>Quarter-Turn Core Products</b>	
Configurations.....	3
Modular Assembly.....	4
Frame Design.....	5
Power Cylinder and Spring Cartridge Design.....	6
Override Options and Certifications .....	7
Core Product Types	
• Quarter-Turn Pneumatic.....	8
• Quarter-Turn Pneumatic (VA Series).....	9
• Quarter-Turn Hydraulic.....	10
• Quarter-Turn Hydraulic Subsea.....	11
• Quarter-Turn Gas-Over-Oil.....	12
• Quarter-Turn Direct Gas .....	13
Linear Core Product Types	
• Linear Pneumatic .....	14
• Linear Hydraulic.....	15
• Linear Gas-Over-Oil.....	16
• Linear Subsea .....	17

## Controls and Accessories

• Valve Control Board for Pneumatic Actuators.....	18
• Pneumatic Control Manifold .....	19
• Hydraulic Self-Contained Controls.....	20
• Hydraulic Power Unit .....	21
• High-Pressure Gas Controls.....	22
• Electronic Linebreak .....	23
Technology and Quality.....	24
Services for Actuation and Valves.....	25

## LEDEEN Actuator and Control Solutions

SOLID ENGINEERING PRINCIPLES. FIELD-PROVEN EXPERIENCE.  
CUSTOMER-CONFIDENT SOLUTIONS.

Cameron's LEDEEN® actuator and control solutions have been consistently providing exceptional valve automation performance to the oil and gas industry for more than 60 years. Starting in 1948, a robust product design was introduced based upon solid engineering principles with a commitment to continuous improvement. Each successive year was guided consistently by those foundational principles while gaining product exposure to a wide range of operational conditions. Meanwhile, an extensive accumulation of first-hand application experience was being established. This resulted in Cameron's ability to provide field-proven solutions that are known to be fit for purpose and reliable.

There's no shortcut or substitution for valuable product knowledge obtained through years of successful operations in the brutal environmental conditions of desert, arctic, offshore or subsea applications. Relying upon this extensive global experience and applying it during the evaluation of every requirement is a commitment to best practices that every customer benefits from when working with Cameron. Whether the need for valve automation is considered basic or complex, upstream to downstream, onshore to offshore, every application deserves the benefits that our LEDEEN actuator and control solutions can provide.



# Quarter-Turn Core Products

## CONFIGURATIONS

### PNEUMATIC



*Spring Return*

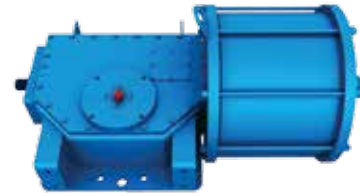

*Double Acting*

### HYDRAULIC



*Spring Return*

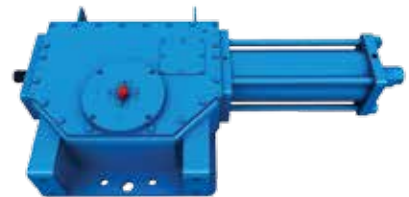

*Double Acting*

### GAS-OVER-OIL



*Double Acting*

### DIRECT GAS

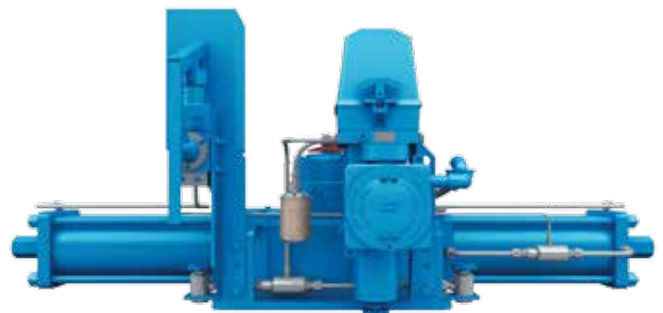

*Double Acting*

## MODULAR ASSEMBLY

### Consistent and Flexible

Consistent engineering design and efficient modular assembly allows increased operational flexibility to be achieved. Double-acting, spring fail close/open or manual override operations are combinations that are readily obtainable on the low-pressure air, high-pressure gas or hydraulic products. This maintains product consistency throughout any project requirement, regardless of valve

size, class, actuator supply medium, pressure, or actuator function (DA/SR) requirements. As a result, all products can be safely and confidently operated by personnel. In addition, the consistent design provides a significant reduction in the quantity of recommended spare parts and seal kits, which reduces costs within maintenance programs.

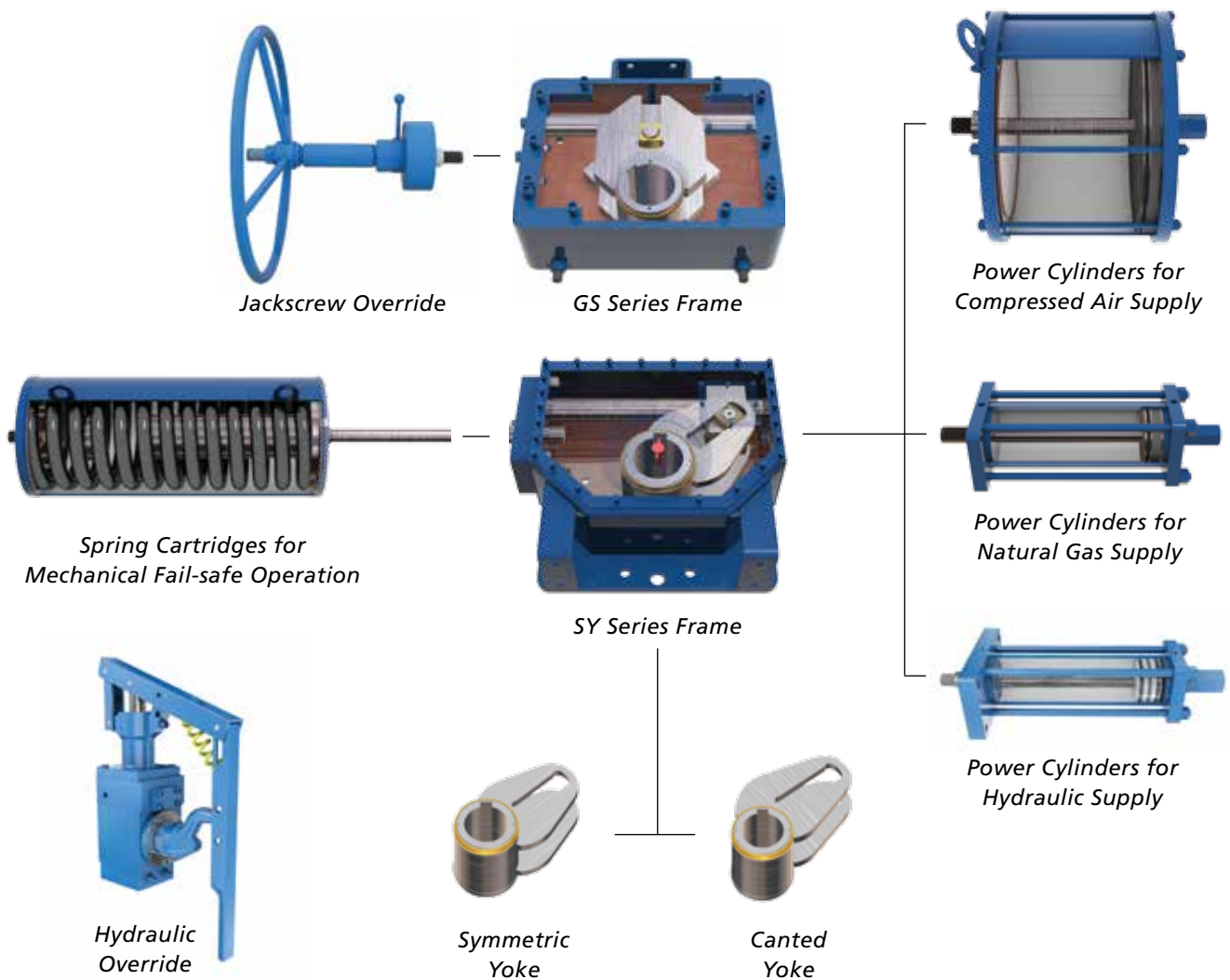

## FRAME DESIGN

### Standard Features

- Scotch yoke mechanism generates powerful opening and closing torque outputs
- Steel fabricated frame provides rugged foundation of modular assemblies
- Chrome-plated side load bar with guide block for effective elimination of piston rod deflection
- Bronze bushing interfaces provide low-friction support of sliding and rotating components
- Aluminum bronze sliding blocks for a low-friction, low-stress pin connection

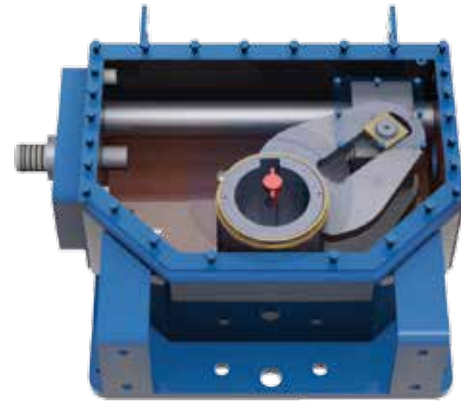

*Fabricated Frame*

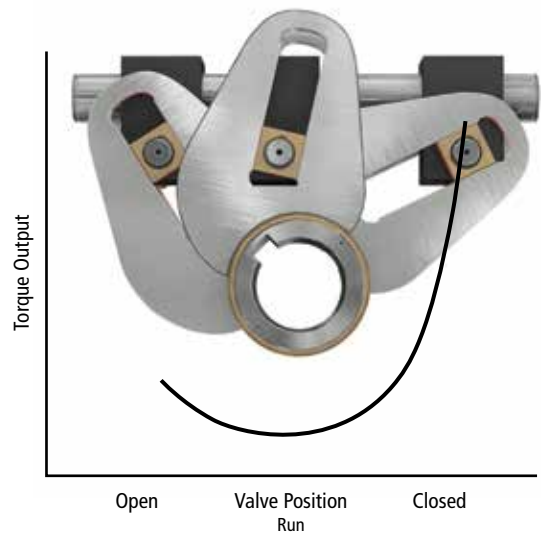
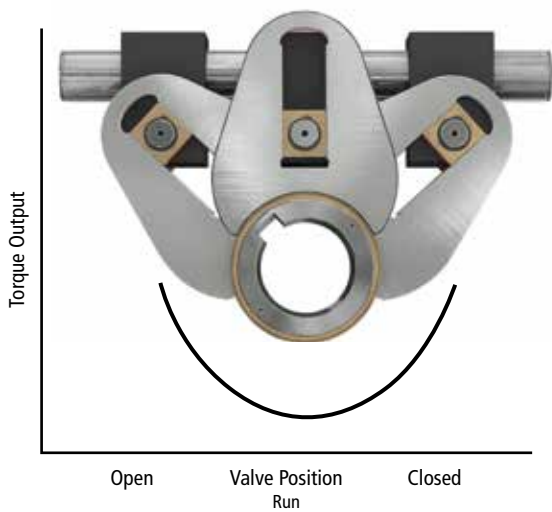

### Symmetric Yoke Design

- Provides conventional torque output
- Equivalent break and end torque values

### Canted Yoke Design

- Provides unique torque output
- Increases break and reseal torque values

## POWER CYLINDER AND SPRING CARTRIDGE DESIGN

### Power Cylinder Standard Features

- Steel cylinder assemblies, each designed specifically for the safe pressure containment of low-pressure compressed air, high-pressure gas or high-pressure hydraulic supply mediums (refer to pages 8, 10, 12 and 13 for specific pressure ratings)
- Nickel or hard-chrome plated cylinder ID ensures excellent sealing surface with superior corrosion resistance
- Buna O-rings used for zero-leakage piston operation with a low-pressure supply medium, while Buna Quad rings are used with a high-pressure gas or hydraulic supply medium
- Composite guide band on piston provides low-friction guidance and support

### Spring Cartridge Standard Features

- Steel spring cartridge is fully enclosed from environmental conditions
- Epoxy-coated prestressed springs provide consistent performance with corrosion protection
- Seal-welded design construction provides increased personnel safety

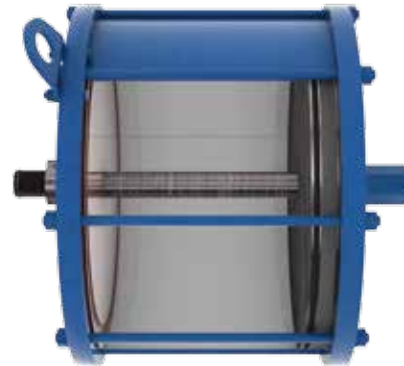

*Power Cylinders for Compressed Air Supply*

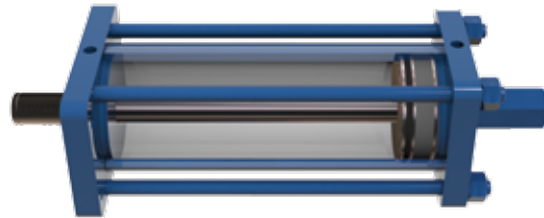



*Power Cylinders for Hydraulic and Natural Gas Supply*



*Spring Cartridges for Mechanical Fail-safe Operation*

## STANDARD PRODUCT CHARACTERISTICS

ACTUATOR SERIES	TEMPERATURE RANGE	PRESSURE RANGE
GS and SY	 -22° F to 212° F (-30° C to 100° C)	 40 to 3000 psig (3 to 207 barg)



## VERRIDE OPTIONS AND CERTIFICATIONS

- Jackscrew with handwheel for operating any double-acting or spring-return actuator up through the SY10 model
- Hydraulic pump for easy operation of all actuator sizes and configurations
- Gear with handwheel provides dual function of valve mounting hardware with override capability for any model double-acting or spring-return actuator

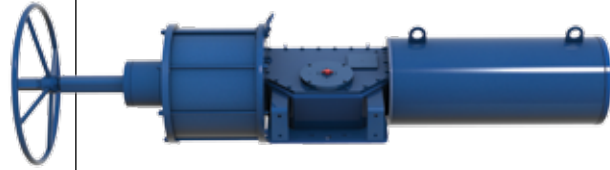

*Pneumatic Spring Return with Jackscrew Override*

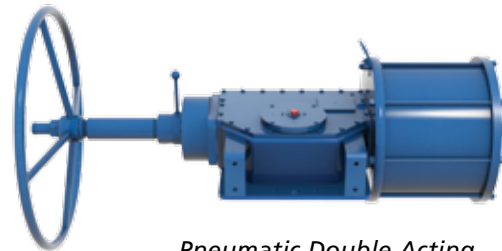

*Pneumatic Double Acting with Jackscrew Override*



*Pneumatic Double Acting with Hand Pump Override*

### Certifications

Cameron's LEDEEN actuators comply with many industry standards:

- ISO 9001:2008, Quality
- PED 97/23/CE 2002, Quality
- SI 825, 1996 Pipeline Safety
- IEC 61508:2010, Integrity (TUV/SIL3)
- TR CU, Safety and Quality

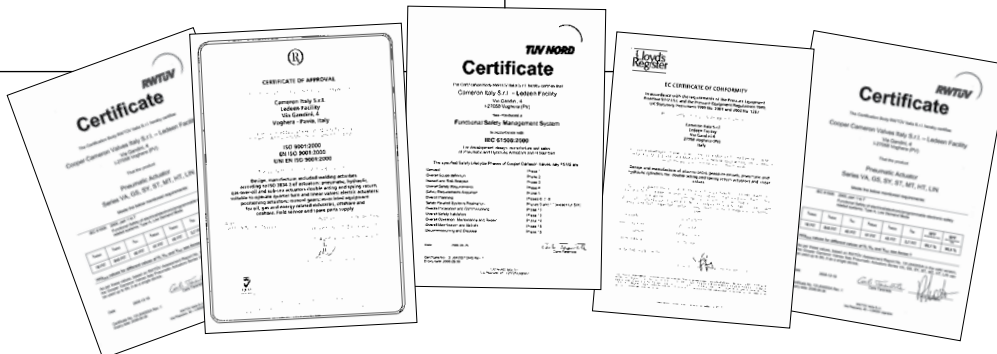

## Core Product Types

### QUARTER-TURN PNEUMATIC

#### Typical Application

Quarter-turn pneumatic actuators are used for on/off or modulating control of any ball, plug or butterfly valve utilizing compressed air, natural gas or nitrogen actuator supply.

#### Standard Features

- All models available as double acting or spring return
- Torque outputs to 5,700,000 in-lb (644,000 Nm)
- Open and close travel stops,  $\pm 3$  degrees minimum
- Local position indication
- Refer to pages 5 and 6 for frame, power cylinder and spring cartridge features
- Suitable for SIL3 environments

#### Available Options

- Jackscrew, hydraulic and gear overrides (refer to page 7)
- Mechanical partial stroke test device (local or remote operation)
- Fluorosilicone seals for low-temperature applications:  $-76^{\circ}\text{ F}$  ( $-60^{\circ}\text{ C}$ )
- Viton<sup>®</sup> seals for high-temperature applications:  $392^{\circ}\text{ F}$  ( $200^{\circ}\text{ C}$ )
- Ultra-low temperature materials:  $-76^{\circ}\text{ F}$  ( $-60^{\circ}\text{ C}$ )
- Refer to page 18 for pneumatic control option

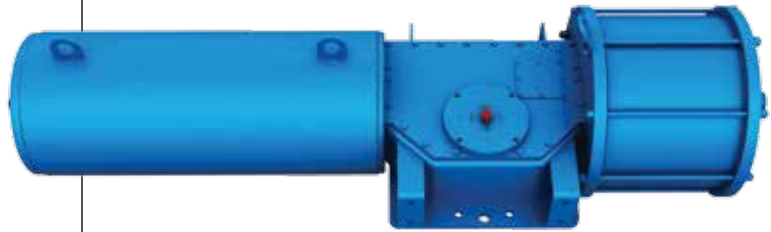

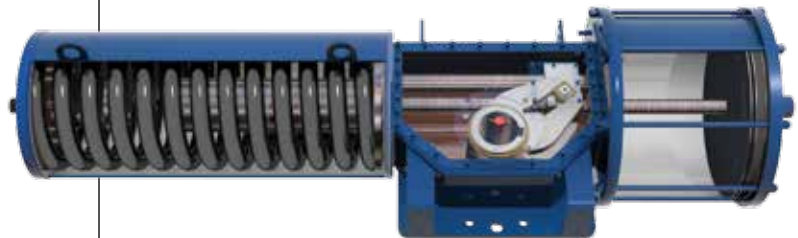

*Quarter-turn Pneumatic*



*Pneumatic Spring Return*

### STANDARD PRODUCT CHARACTERISTICS

ACTUATOR MODELS	TEMPERATURE RANGE	PRESSURE RANGE
GS and SY	 $-22^{\circ}\text{ F}$ to $212^{\circ}\text{ F}$ $(-30^{\circ}\text{ C}$ to $100^{\circ}\text{ C})$	 40 to 175 psig (3 to 12 barg)

## QUARTER-TURN PNEUMATIC (VA SERIES)

### Typical Application

Quarter-turn pneumatic actuators are used for on/off or modulating control of any ball, plug or butterfly valve utilizing compressed air, natural gas or nitrogen actuator supply.

### Standard Features



- Available as double acting or spring return
- Torque outputs to 9700 in-lb (1100 Nm)
- Forged steel body, piston and end caps
- Steel cylinders with nickel-plated I.D.
- Symmetric yoke
- Aluminum bronze sliding blocks in yoke
- Composite guide sleeve on piston
- Open and close travel stops,  $\pm 3$  degrees minimum
- Local position indication
- Suitable for SIL3 environments
- Refer to page 20 for pneumatic control option

### Available Options

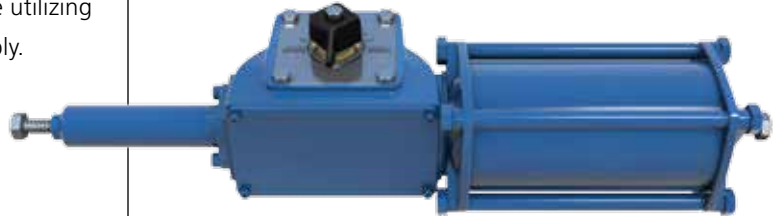
- Stainless steel cylinders
- Fluorosilicone seals for low-temperature applications:  $-76^{\circ}\text{F}$  ( $-60^{\circ}\text{C}$ )
- Viton seals for high-temperature applications:  $392^{\circ}\text{F}$  ( $200^{\circ}\text{C}$ )
- Jackscrew with handwheel for operating any double-acting or spring-return model
- Gear with handwheel provides dual function of valve mounting hardware with override capability for any double-acting or spring-return model



## STANDARD PRODUCT CHARACTERISTICS

ACTUATOR MODEL	TEMPERATURE RANGE	PRESSURE RANGE
VA	 $-22^{\circ}\text{F}$ to $212^{\circ}\text{F}$ $(-30^{\circ}\text{C}$ to $100^{\circ}\text{C})$	 40 to 174 psig (3 to 12 barg)

## QUARTER-TURN HYDRAULIC

### Typical Application

Quarter-turn hydraulic actuators are used for on/off or modulating control of any ball, plug or butterfly valve utilizing hydraulic actuator supply.

### Standard Features



- All models available as double acting or spring return
- Torque outputs to 5,700,000 in-lb (644,000 Nm)
- Open and close travel stops,  $\pm 3$  degrees minimum
- Local position indication
- Refer to pages 5 and 6 for frame, power cylinder and spring cartridge features
- Suitable for SIL3 environments
- Refer to pages 19 and 20 for hydraulic control options

### Available Options

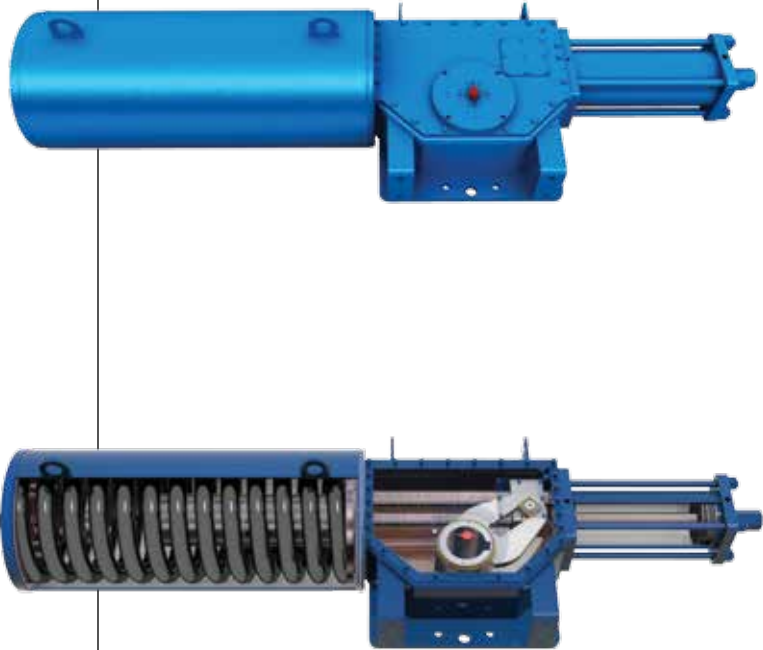
- Jackscrew, hydraulic and gear overrides (refer to page 7)
- Mechanical partial stroke test device (local or remote operation)
- Fluorosilicone seals for low-temperature applications: -76° F (-60° C)
- Viton seals for high-temperature applications: 392° F (200° C)
- Ultra-low temperature materials: -76° F (-60° C)



## STANDARD PRODUCT CHARACTERISTICS

ACTUATOR SERIES	TEMPERATURE RANGE	PRESSURE RANGE
GS and SY	 -22° F to 212° F (-30° C to 100° C)	 145 to 3000 psig (10 to 207 barg)

## QUARTER-TURN HYDRAULIC SUBSEA

### Typical Application

For on/off control of any subsea ball, plug or check valve in a submerged environment beyond 500 ft (152 m) water depth.

### Standard Features

- Available as double acting or spring return
- Torque outputs to 3,600,000 in-lb (400,000 Nm)
- Scotch yoke mechanism
- Pressure-compensated for deep applications
- 100% RX and PT tested welds
- No external tie rods
- Open and close travel stops,  $\pm 5$  degrees minimum
- Local tactile position indicator
- Spool piece with adjustable position locators

### Available Options

- Manual override
- ROV override
- Microswitch for open/close indication
- Position transmitter for 0% to 100% travel indication



### Typical Application

For on/off control of any quarter-turn operated valve in a submerged environment to 500 ft (152 m) water depth.

### Standard Features and Benefits

- Available as double acting or spring return
- Torque output to 5,700,000 in-lb (644,000 Nm)
- Open and close travel stops provide  $\pm 3$  degrees minimum
- Scotch yoke mechanism
- Buna piston seal
- Composite guide band on piston
- Epoxy-coated springs
- Pressure compensator

### Available Options

- Manual override
- ROV override
- Microswitch for open/close indication
- Position transmitter for 0% to 100% travel indication



## STANDARD PRODUCT CHARACTERISTICS

ACTUATOR MODEL	SUBMERSION (WATER DEPTH)	PRESSURE RANGE
Deepwater Series	> 500 ft (152 m)	 150 to 3000 psig (10 to 207 barg)
Shallow-water Series	≤ 500 ft (152 m)	

## QUARTER-TURN GAS-OVER-OIL

### Typical Application

Quarter-turn gas-over-oil actuators are used for on/off control of any natural gas transmission ball or plug valve utilizing a high-pressure natural gas or nitrogen actuator supply.

### Standard Features



- All models available as double acting
- Torque outputs to 5,700,000 in-lb (644,000 Nm)
- Open and close travel stops,  $\pm 3$  degrees minimum
- Local position indication
- ASME/PED gas-over-oil pressure vessels with dipstick, filter and adjustable speed controls
- High-pressure rated controls for local, remote and automatic operation (refer to pages 21 and 22)
- Hydraulic manual override
- Refer to pages 5 and 6 for frame and power cylinder features
- Suitable for SIL3 environments

### Available Options

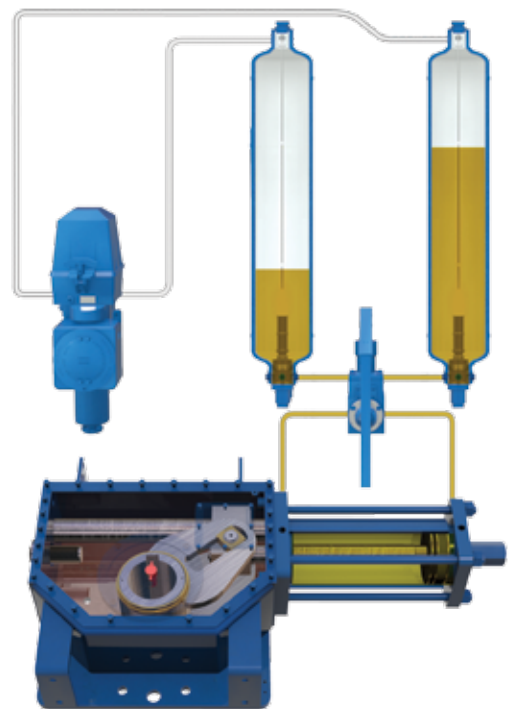
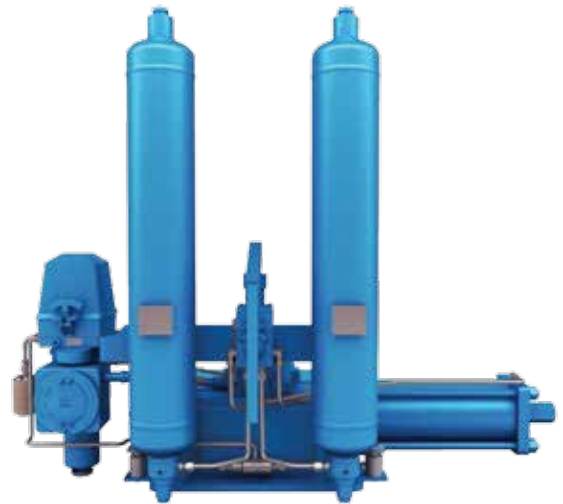
- Fluorosilicone seals for low-temperature applications:  $-76^{\circ}\text{F}$  ( $-60^{\circ}\text{C}$ )
- Viton seals for high-temperature applications:  $392^{\circ}\text{F}$  ( $200^{\circ}\text{C}$ )
- Ultra-low temperature materials:  $-76^{\circ}\text{F}$  ( $-60^{\circ}\text{C}$ )
- ASME/PED emergency storage tank



## STANDARD PRODUCT CHARACTERISTICS

ACTUATOR SERIES	TEMPERATURE RANGE	PRESSURE RANGE
GS and SY	 $-22^{\circ}\text{F}$ to $212^{\circ}\text{F}$ $(-30^{\circ}\text{C}$ to $100^{\circ}\text{C})$	 145 to 1500 psig (10 to 104 barg)

## QUARTER-TURN DIRECT GAS

### Typical Application

Quarter-turn direct gas actuators are used for on/off control of any natural gas transmission ball or plug valve utilizing a high-pressure natural gas or nitrogen actuator supply.

### Standard Features



- All models available as double acting
- Torque outputs to 5,700,000 in-lb (644,000 Nm)
- Open and close travel stops,  $\pm 3$  degrees minimum
- Local position indication
- Hydraulic manual override with reservoir filter, dipstick and adjustable speed controls
- High-pressure rated controls for local, remote and automatic operation (refer to pages 21 and 22)
- Refer to pages 5 and 6 for frame and power cylinder features
- Suitable for SIL3 environments

### Available Options

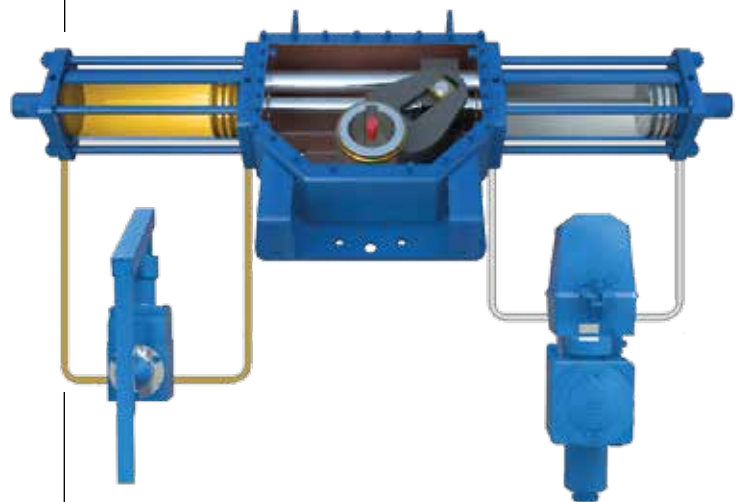
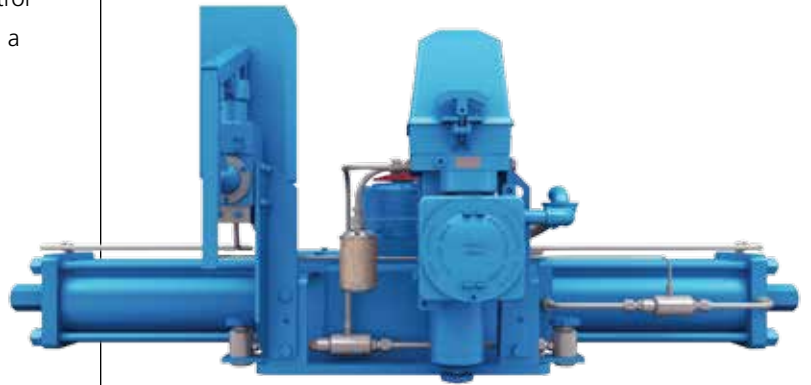
- Fluorosilicone seals for low-temperature applications: -76° F (-60° C)
- Viton seals for high-temperature applications: 392° F (200° C)
- Ultra-low temperature materials: -76° F (-60° C)
- ASME/PED emergency storage tank
- Spring-return models



## STANDARD PRODUCT CHARACTERISTICS

ACTUATOR MODELS	TEMPERATURE RANGE	PRESSURE RANGE
GS and SY	 -22° F to 212° F (-30° C to 100° C)	 145 to 1500 psig (10 to 104 barg)

## Linear Core Product Types

### LINEAR PNEUMATIC

#### Typical Application

Linear pneumatic actuators are used for on/off control of any gate valve or rising stem ball valve utilizing compressed air, natural gas or nitrogen actuator supply.

#### Piston Actuator Standard Features



- All models available as double acting or spring return
- Thrust outputs to 4,400,000 lb (19,572,000 N)
- Local position indication
- Refer to page 6 for power cylinder and spring cartridge features
- Suitable for SIL3 environments
- Refer to page 18 for pneumatic control option

#### Available Options

- Mechanical jackscrew override
- Hydraulic manual override
- Fluorosilicone seals for low-temperature applications: -76° F (-60° C)
- Viton seals for high-temperature applications: 392° F (200° C)
- Ultra-low temperature materials: -76° F (-60° C)



### STANDARD PRODUCT CHARACTERISTICS

ACTUATOR MODEL	TEMPERATURE RANGE	PRESSURE RANGE
LP	 -22° F to 212° F (-30° C to 100° C)	 40 to 175 psig (3 to 12 barg)



## LINEAR HYDRAULIC

### Typical Application

Linear hydraulic actuators are used for on/off control of any gate valve or rising stem ball valve utilizing a hydraulic actuator supply.

### Standard Features



- All models available as double acting or spring return
- Thrust outputs to 4,400,000 lb (19,500,000 N)
- Local position indication
- Refer to page 6 for power cylinder and spring cartridge features
- Suitable for SIL3 environments
- Refer to pages 19 and 20 for hydraulic control options

### Available Options

- Mechanical jackscrew override
- Hydraulic manual override
- Fluorosilicone seals for low-temperature applications:  
-76° F (-60° C)
- Viton seals for high-temperature applications:  
392° F (200° C)
- Operating pressure to 5000 psig (345 barg)
- Ultra-low temperature materials: -76° F (-60° C)



### STANDARD PRODUCT CHARACTERISTICS

ACTUATOR MODEL	TEMPERATURE RANGE	PRESSURE RANGE
LH	 -22° F to 212° F (-30° C to 100° C)	 145 to 3000 psig (10 to 207 barg)

## LINEAR GAS-OVER-OIL

### Typical Application

Linear gas-over-oil actuators are used for on/off control of any natural gas transmission gate valve utilizing a high-pressure natural gas or nitrogen actuator supply.

### Piston Actuator Standard Features



- Available as double acting
- Thrust outputs to 4,400,000 lb (19,572,000 N)
- Local position indication
- ASME/PED gas-over-oil pressure vessels with dipstick, filter and adjustable speed controls
- High-pressure rated controls for local, remote and automatic operation (refer to pages 21 and 22)
- Hydraulic manual override
- Refer to page 6 for power cylinder features
- Suitable for SIL3 environments

### Available Options

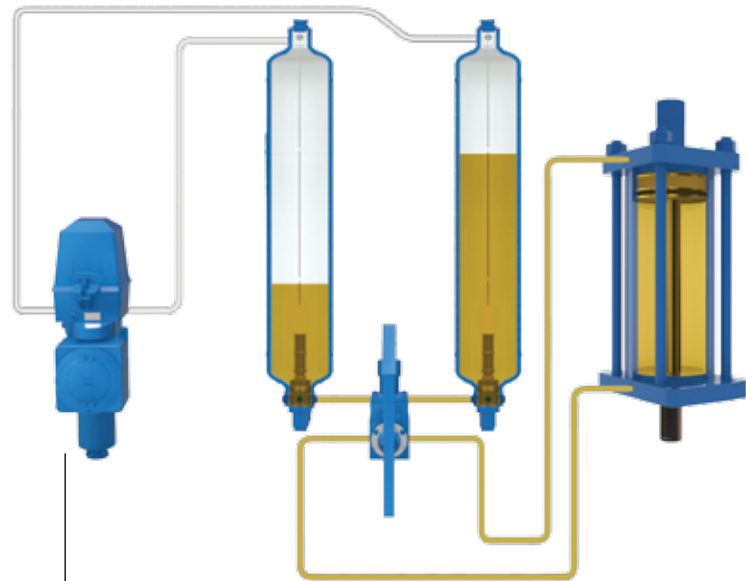
- Fluorosilicone seals for low-temperature applications: -76° F (-60° C)
- Viton seals for high-temperature applications: 392° F (200° C)
- Ultra-low temperature materials: -76° F (-60° C)
- ASME/PED emergency storage tank



## STANDARD PRODUCT CHARACTERISTICS

ACTUATOR MODEL	TEMPERATURE RANGE	PRESSURE RANGE
LH-GH	 -22° F to 212° F (-30° C to 100° C)	 145 to 1500 psig (10 to 104 barg)

## LINEAR SUBSEA

### Typical Application

Linear subsea actuators are used for on/off control of any subsea gate valve utilizing a hydraulic actuator supply.

### Standard Features

- Available as double acting or spring return
- Thrust outputs to 4,400,000 lb (19,500,000 N)
- Pressure-compensated for deep applications
- 100% RX and PT tested welds
- No external tie rods or tubing

### Available Options

- ROV override
- Diver intervention
- In-house hyperbaric testing

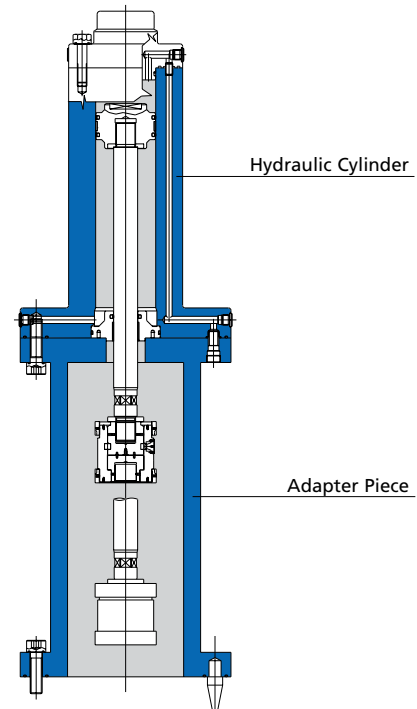

## STANDARD PRODUCT CHARACTERISTICS

ACTUATOR MODEL	PRESSURE RANGE
Mytilus	 150 to 3000 psig (10 to 207 barg)

## VALVE CONTROL BOARD FOR PNEUMATIC ACTUATORS

Designed using in-field, real world problem solving and keeping serviceability in mind, this VCB offers one of the highest levels of reliability and safety on the market today. The system has been developed to provide a turnkey control panel for the most common logics used for on/off valves in oil and gas applications. The LEDEEN VCB for pneumatic actuators is capable of a variety of operations, including increasing flow capacities and suite operation requests on stroking time on a wide range of actuators.

### Technical Data

#### Panel:

Control system components are mounted on a SS 316 panel complete with a sunshade

#### Dimensions:

Panel has a very compact design – overall dimensions are 18" x 16" x 10" (450 mm x 400 mm x 250 mm) for fail-open and fail-closed schematics for spring return actuators and 22" x 18" x 10" (550 mm x 450 mm x 250 mm) for stay put schematics for double acting actuators.

#### Mounting:

Different assembling options are available:



- On board (panel mounted directly to LEDEEN actuator)
- On 2" pole (mounting kit separately delivered on request)
- Wall mounted (mounting kit separately delivered on request)

#### Tubing and Fittings:

- Tubing: SS 316L – imperial size (metric available on request)
- Fittings: SS 316 double ferrule type (Swagelok)



## STANDARD PRODUCT CHARACTERISTICS

CONTROL MODELS	TEMPERATURE RANGE	PRESSURE RANGE
VCB	 -40° F to 200° F (-40° C to 93° C)	 0 to 175 psig (0 to 12 barg)

## PNEUMATIC CONTROL MANIFOLD

### Typical Application

Low-pressure pneumatic controls are used for local, remote or automatic control of any low-pressure pneumatic actuator.

### Standard Features



- Compact manifold design
- 316 stainless steel construction
- High flow capacity
- Accepts multiple solenoid brands
- Approved to NEMA and ATEX standards
- Control double-acting and spring-return actuators
- Adaptable for custom applications
- FKM fluorocarbon Viton seals
- Suitable for SIL3 environments

### Available Options

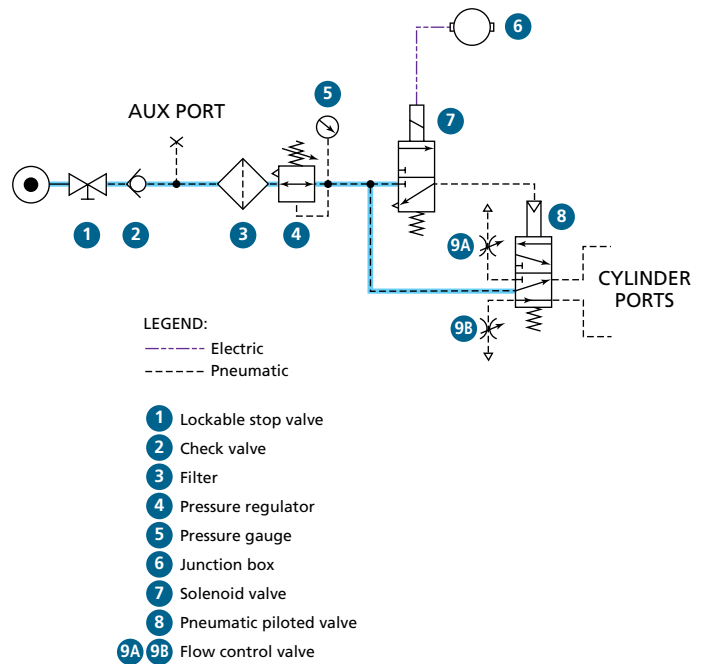
- Pilot or electrical control signal
- ASCO, Midland or Versa solenoid
- Lever or palm button manual operator
- Latching detent and manual reset devices
- Low power consumption
- EPDM seals for low-temperature applications



## STANDARD PRODUCT CHARACTERISTICS

CONTROL MODELS	TEMPERATURE RANGE	PRESSURE RANGE
Local, Remote and Automatic	 -40° F to 200° F (-40° C to 93° C)	 0 to 175 psig (0 to 12 barg)

## HYDRAULIC SELF-CONTAINED

### Typical Application

Hydraulic self-contained controls are used for providing a reliable valve shutdown capability when an external power source for the actuator is either not available or not dependable.

### Standard Features

- Models available with 3000 psig and 5000 psig pressure outputs
- Corrosion-resistant anodized aluminum with stainless steel internals
- Manual arming valve with bright red colored local emergency shutdown trip function
- Thermal compensation for high- and low-pressure circuits
- Independently adjustable pilot valves for PSH and PSL
- Stainless steel pressure gauges for high- and low-pressure circuits
- Easy-view liquid level gauge attached to stainless steel reservoir

### Available Options

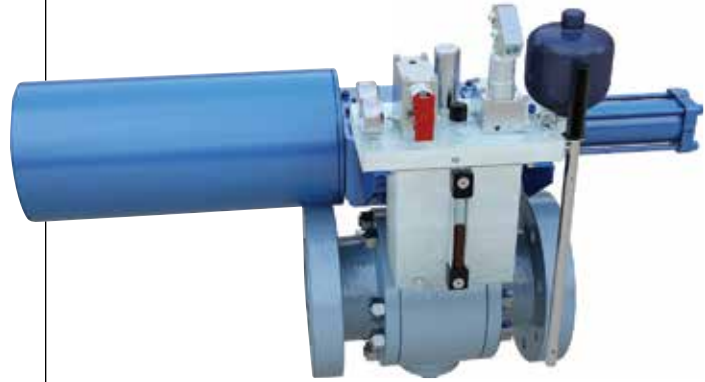

- Low power consumption solenoid for remote trip
- Lockable stainless steel enclosure
- Fusible plug



*Typical Self-contained Assembly*



## STANDARD PRODUCT CHARACTERISTICS

CONTROL MODELS	TEMPERATURE RANGE	PRESSURE RANGE
Self-contained	 -50° F to 212° F (-45° C to 100° C)	 3000 psig and 5000 psig (207 barg and 345 barg)

## HYDRAULIC POWER UNIT

### Typical Application

The hydraulic power unit provides a reliable high-pressure hydraulic output as a power source for hydraulic actuators.

### Electric Motor Operated

- Available for mounting on the actuator or remotely

### Centralized

- Provides power for a large quantity of actuators simultaneously
- Hydraulic controls for all actuators are centralized



### Portable Gasoline or Diesel Operated

- Mobile power source for individual actuator requirements
- Flexible hoses with quick disconnects

### Solar Operated

- Available for single or multiactuator requirements
- Completely self-contained
- Emergency storage capability



POWER UNITS	TEMPERATURE RANGE	PRESSURE RANGE
Electric, Gasoline, Diesel or Solar	 -40° F to 212° F (-40° C to 100° C)	 145 to 3000 psig (10 to 207 barg)

## HIGH-PRESSURE GAS

### Typical Application

High-pressure gas controls are used for local, remote or automatic control of any high-pressure gas actuator utilizing a natural gas or nitrogen supply.

### Standard Features



- Compact design with weatherproof enclosure
- All components have high-pressure rating
- Three-stage gas filter/conditioner
- Easy operation of manual levers throughout pressure range
- Durable marine grade materials
- Converts from local to remote or automatic operation

### Available Options

- Electric remote
- Electric fail-safe
- Emergency shutdown
- High/low-pressure shutdown
- Linebreak (diaphragm, digital or electronic)
- Station bypass
- Various configurations or special requirements



## STANDARD PRODUCT CHARACTERISTICS

CONTROL MODELS	TEMPERATURE RANGE	PRESSURE RANGE
Local, Remote and Automatic	 -76° F to 212° F (-60° C to 100° C)	 145 to 1500 psig (10 to 104 barg)



## ELECTRONIC LINEBREAK

### Typical Application

Electronic linebreak controls are used for monitoring pipeline operating conditions to quickly detect pressure trending toward abnormally high or low rate-of-drop values and accurately monitor those trends for an automatic shutdown response when pre-established set points are reached.

### Standard Features

- Continuous pipeline pressure monitoring and data acquisition
- Initiates valve closure when PSH, PSL or ROD limits are reached
- CSA certified for Class 1, Div. 2 hazardous locations
- Weather-tight NEMA 4 enclosure supports integral battery
- Enclosure allows mounting of single- or dual-pressure transmitters
- User-assignable data for local display on large-character LCD screen
- RS 232 and RS 485 communication connections

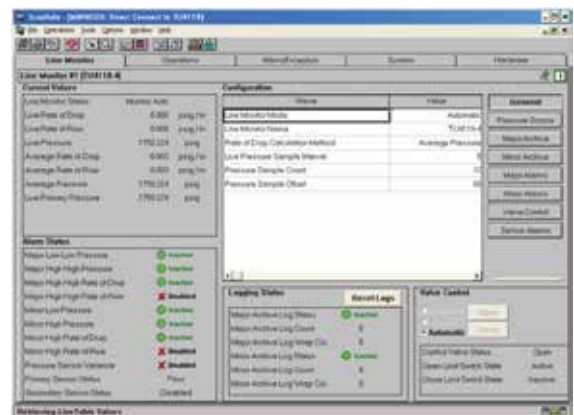

### Available Options

- Solar powered (panel with all associated circuit accessories)
- Dual-pressure transmitters for redundancy or dP monitoring
- Expansion board for additional I/O connections



*Line Monitor Screen Display*

## STANDARD PRODUCT CHARACTERISTICS

CONTROL MODELS	TEMPERATURE RANGE	PRESSURE RANGE
SafeMaster	 -40° F to 140° F (-40° C to 60° C)	 Pressure transmitter dependent

## Technology and Quality

As established leaders in actuation technology, Cameron's LEDEEN brand offers a complete line of actuation and control solutions across a range of flow control applications.

Through technological advancements, LEDEEN actuators deliver a range of capabilities, power and performance in both quarter-turn and linear configurations.

For local, remote or automatic operation, our LEDEEN line features innovative products with intelligent actuation technology designed for some of the world's most demanding applications.

### Specialized Equipment

- To verify performance in actual subsea working conditions, LEDEEN actuators go through stringent hyperbaric testing procedures in simulated environments to ensure all products meet and exceed industry standards
- Cameron has the capability to validate LEDEEN actuator torque output to 13,300,000 in-lb (1,500,000 Nm)



Although checked for accuracy at the time of printing, Cameron's commitment of continuous improvement and innovation may have resulted in product enhancements or modifications not currently shown.

## Services for Actuation and Valves

WE BUILD IT. WE BACK IT.

### Startup and Commissioning

Our experts understand that each project is unique. That's why Cameron's service team helps facilitate commissioning and startup activities.

- Integrated solutions, onsite or at our global service centers
- Increased equipment and product performance
- The shortest possible trouble-free startup for your critical assets

### Spare Parts and Asset Management

Cameron offers the assets and expertise to cover all aspects of valve management.

- Full inventory of quality exact OEM parts and spares
- Complete asset risk and criticality assessments
- Comprehensive inventory of your assets, including a complete recommended spare valves and parts list

### Operational Support

Cameron's ability to address valve requirements in the field is a reflection of our commitment to life-of-asset support.

- Innovative asset management solutions
- Trouble-free installation, startup and operations
- Support from commission to operation – extending through all phases of a valve's life cycle
- Extensive inventory of spare valves and parts

Cameron's site management mitigates the risk of project delays by identifying issues in the construction process prior to valve installation to ensure valve integrity.



3250 Briarpark Drive, Suite 300  
Houston, TX 77042  
USA  
Toll Free 1.800.323.9160

Via Gandini 4  
27058 Voghera, PV  
Italy  
Tel 39.0383.343311

Visit us at [www.c-a-m.com/LEDEEN](http://www.c-a-m.com/LEDEEN)



#### **HSE Policy Statement**

At Cameron, we are committed ethically, financially and personally to a working environment where no one gets hurt and nothing gets harmed.